

COVER POOLS®

Peace of Mind. Designed.

Automatic Pool & Spa Covers

Featuring the T4 System with Stainless Steel Cable



COVER-POOLS LETS YOU FOCUS ON FUN



If you already have a pool, or if you're planning to build one, remember a Cover-Pools automatic pool cover is the best way to safeguard loved ones, save money on heating costs and chemicals and protect your investment.

Find out for yourself what delighted pool owners all over the world have already discovered—our automatic pool cover is the finest, safest, and easiest-to-use pool cover you can buy. So, kick back, relax, and enjoy all the benefits of pool ownership. Cover-Pools has you covered.



Protect your pool and your loved ones.



WARNING: Do not walk or stand on cover except in an emergency.

WITH A POOL COVER, YOU GET PEACE OF MIND

With a Cover-Pools cover you get peace of mind with the simple turn of a key. In under a minute your pool is easily covered or uncovered. Your Cover-Pools cover acts as a “horizontal fence” for your pool, preventing access by children, pets, and uninvited visitors. And while there’s no substitute for proper supervision, your pool can be protected even when you’re not around. It’s a safety barrier that no pool should be without.



Designed for Safety

Cover-Pools covers are tested and listed by Underwriters Laboratories (UL), an independent Nationally Recognized Testing Laboratory (NRTL), as being in conformance with the applicable requirements of performance & safety standards such as ASTM F1346-91, published by the American Society of Testing and Materials (ASTM).



Follow all safety and warning notices found in the owners manual.

A POOL COVER SAVES UP TO 70% ON OPERATING COSTS



The U.S. Department of Energy states* that a pool cover is “the single most effective means of reducing pool heating costs.”

Saving you up to 70% on pool operating costs, a pool cover also helps prevent the evaporation of both precious water and expensive chemicals. It even acts as a passive solar heater by capturing the sun’s radiant heat extending your swimming season.

A Cover-Pools cover extends your swimming season by reducing heat loss.

At the same time, a pool cover keeps dirt and debris out of the pool, reducing cleaning, maintenance costs and overall wear on pool equipment. Cover-Pools covers have proven to be one of the best ways of reducing pool expenses all year long.

*<https://www.energy.gov/energysaver/swimming-pool-covers>

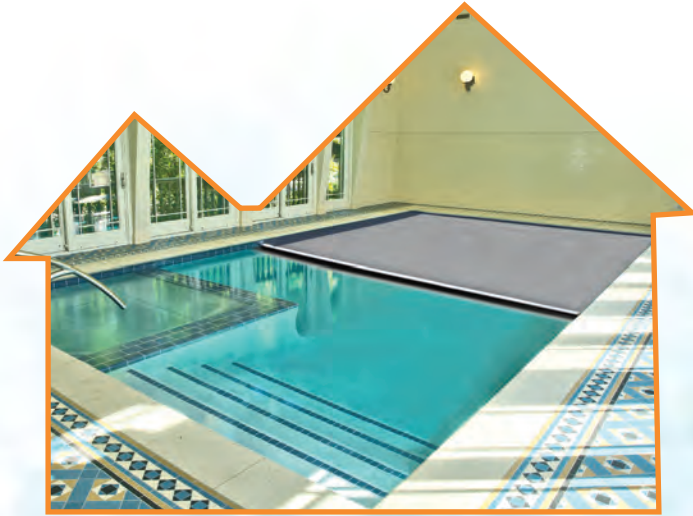

For indoor pools, a cover provides the added benefit of eliminating the need for expensive dehumidification systems.

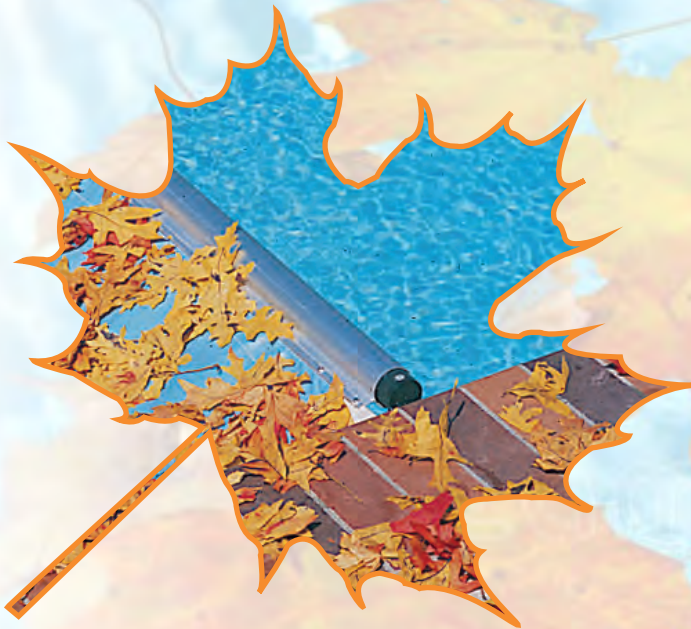

Spend time swimming, not cleaning.



Saves energy, adds heat.

A Cover-Pools cover dramatically reduces heating costs and extends your swimming season by acting as a giant solar collector.



Saves water and chemicals.

By reducing evaporation, your Cover-Pools cover cuts water loss and reduces the use of chemicals.



Saves cleaning.

Minimize the time and effort spent cleaning out dirt, leaves and debris when using an automatic pool cover.



Saves pool equipment, extends pool life.

With a covered pool, you keep the heat in and the dirt and debris out. Heaters and other pool equipment work less and last longer.



Saves money.

By saving heat, chemicals, cleaning, and extending equipment life, your Cover-Pools cover quickly pays for itself. You can save up to 70% on operating costs, which is a great return on your investment.

**The Cover-Pools automatic cover.
One cover, four seasons. ****



**Consult your Cover-Pools Dealer for more details.

ANY POOL, ANY SHAPE—COVER-POOLS HAS YOU COVERED



Vanishing-edge pool

New Construction

At Cover-Pools, we love a good challenge. So go ahead, bring us your freeform pools, your kidney shapes, spas, L shapes, and anything else you can dream up. If you can build it, we can figure out a way to cover it.

Every pool makes its own unique statement, and Cover-Pools believes design should never be an obstacle to the benefits of a strong and dependable pool cover.

Unique Shapes



Deck-on-deck pool



Pool with raised wall

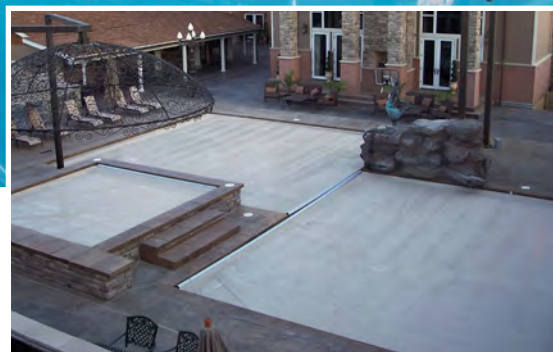

L-shaped pool with two covers and spa

**We can cover your pool
no matter what the shape.**

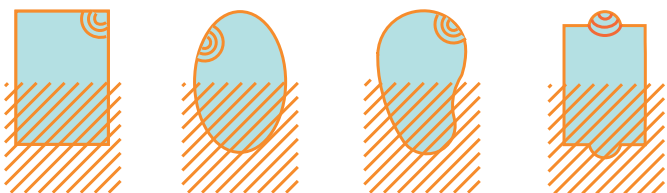

A CUSTOM POOL DESERVES A CUSTOM-DESIGNED SYSTEM



*Cover-Pools has the **best system on the market**. I have worked on every automatic cover out there and none compare in both quality and customer service.*

*Mark Sheinman
Pennco Automatic
Pool Covers*

*We depend on both the high **product quality** and **business integrity** that Cover-Pools is known for. We would not install or recommend any other cover.*

*Alan and Coni Stiles
Arizona Pool Covers*

Custom Applications



Pool with rock features and waterfall



Deck-on-deck pool and spa with rock features and waterfall



Perimeter overflow pool

Since 1962, we've been designing custom covers that accommodate virtually any pool shape or design feature. As pool design evolves and trends develop, Cover-Pools constantly develops new and more creative ways to cover any pool. From waterfalls and rockwork to vanishing edges and other water features, no challenge is too great.

Our staff of experts work with architects, engineers, and builders, providing them with knowledgeable input to help cover the pool of your dreams.

LET OUR TRACKS GUIDE YOU



Undermount Track Systems

Dual Race Undertrack System

Undertrack is a perfect way to fully integrate the cover into the pool and deck. With an Undertrack installation, the tracks are concealed beneath the deck. It's the ultimate in smooth, worry-free operation.

Dual Race Undertrack and Track Channel

For freeform pools with Undertrack, the channel makes it easy to construct deck-on-deck applications around any vinyl, fiberglass, or concrete pool.

Raised Dual Race Track Channel

Raised dual race channel is intended for fiberglass pools. A channel can be placed on the top of the fiberglass pool, then have the deck built on the raised track channel. It is a good choice to be used on free-form shaped fiberglass pools as well.

Undertrack design allows a variety of deck profiles.



Undertrack with Dual Race track channel

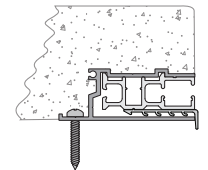

Deck-on-deck with Dual Race track channel

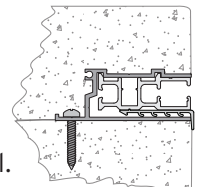

Raised Dual Race track channel

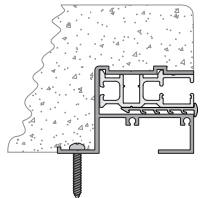

Deck Mount Track Systems

SnapTop™ Track System

SnapTop track is a two-piece track system that conceals the screws from view and creates a smooth, streamlined track surface.

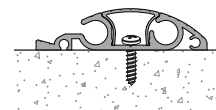

SnapTop track



DUAL RACE V-PAK™ KIT

Cover Kit for Vinyl-Liner Pools

The V-Pak is a complete, easy-to-install cover kit for vinyl-liner pools.

- Cover **unit** and **fabric**
- Comes standard with **Flush Mount** lid that aesthetically covers the recessed housing and creates a flat surface or with **Vanishing Lid** brackets available in 12" or 14" to accommodate custom vanishing lids. (other lid forms available upon request)
- **Channel** option: Dual Race track channel with vinyl retainer or Dual Race bullnose vinyl-liner coping
- Coping for three sides
- Deluxe ultimate polymer box
- Beam Cover with vinyl retainer provides protection for the cover fabric
- Square, 45°, 6" or 24" radius corners
- Four standard pool sizes–
14 x 28, 16 x 32, 18 x 36, 20 x 40

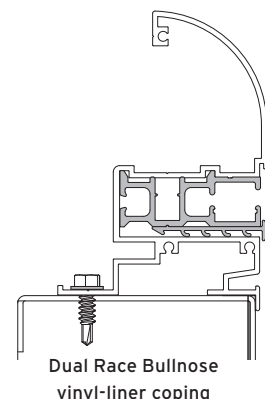
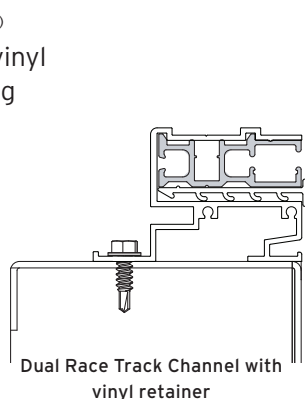
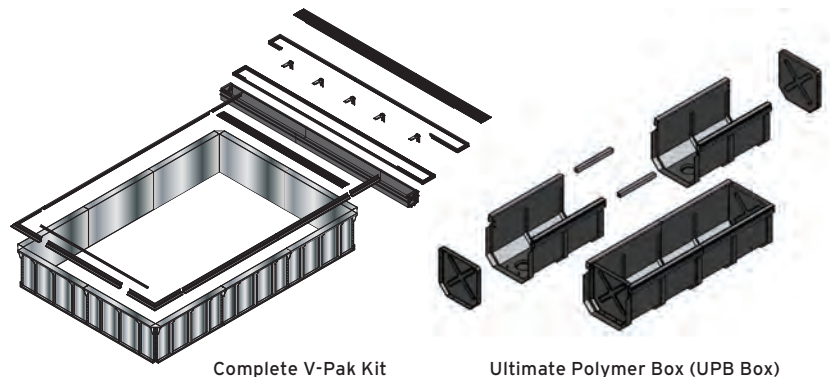



Square Leading Edge

Underside system with square leading edge

Leading Edge and Glider

Round Leading Edge

The leading edge is designed to guide your pool cover across the water ensuring smooth operation and a strong, flush seal at the far-end pool wall. Each Cover-Pools pool cover comes standard with a round leading edge.



Round Leading Edge
(with optional bumper)

Square Leading Edge*

The optional square leading edge adds rigidity over the round leading edge and a modern finish to your pool cover. The square shape reduces deflection making it easier to hide the leading edge and creates a better seal. It may also be wrapped in a separate piece of QuadCore™ fabric for a more seamless look.



Square Leading Edge

*Only available for pools up to 20' wide and applications using adjustable gliders.

Adjustable Glider and Dowel

The adjustable glider and dowel combination can incrementally adjust the leading edge height 3" above or below the track. The adjustable dowel is standard with most undertrack systems.



Glider & Dowel

OUR QUADCORE™ FABRIC IS ENGINEERED FOR DURABILITY



Quality in a Variety of Colors

Cover-Pools exclusive QuadCore™ fabric is the product of 50 years of research and experience. Reinforced with a strong polyester mesh for strength and tear resistance, this high-performance vinyl-resin formula provides maximum durability in the swimming pool environment.



Choose from standard colors shown above. More colors are available in special-order vinyl. Please see actual fabric sample when making color choice; colors may vary.

Strength meets or exceeds the ASTM F1346-91 minimum standard of 485 lbs. per 3' radius



- Material: PVC vinyl, laminated over a reinforced polyester mesh for strength and tear resistance
- Color Match Webbing: Sewn or welded, matching colors available
- Designed for the Pool Environment: UV, mildew, and pool-chemical resistant with superior dimensional stability
- Weight: 18 oz. per square yard
- Thickness: 19 to 23 mil laminated vinyl
- Construction: Fabric is attached to webbing and low-stretch standard rope, ultimate rope or no-stretch stainless steel cable with double-sewn bonded polyester thread for durability

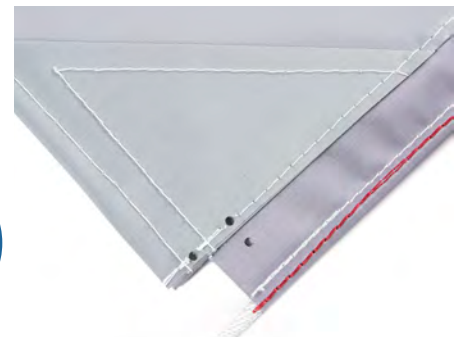

LIDS AND BENCHES



Deck-Mounted Mechanism

When the mechanism is mounted on the deck surface, it can be covered simply with fiberglass ends or the Everlast™ bench. The bench kit offers a convenient, durable, and low-maintenance way to cover your mechanism.

You can also create your own bench design with our bench frames and materials supplied locally by your dealer or an independent contractor.

All polymer panels on the Everlast bench come in four different colors to coordinate with your deck. Please see actual polymer samples when making color choice. Colors may vary.



Everlast bench



White



Tan



Fiberglass ends

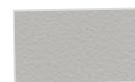

Gray



Terra Cotta

Recessed Mechanism

The mechanism can be discretely housed in a box below the deck surface. This option works best if chosen before construction. However, if there is room to cut into the deck of an existing pool, the mechanism can still be recessed. Cover-Pools offers many lid options for covering the mechanism.



Typical position of leading edge when cover is fully retracted.

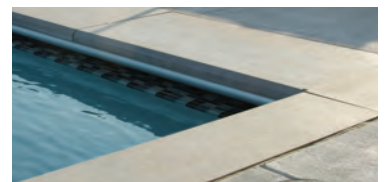

Extended Vanishing Lid™ allows the leading edge of the retracted cover to be hidden.

Easy Roller™

The Easy Roller System reduces cover friction and residual water pooling on top of the fabric making for smoother cover operation. By reducing the friction between the cover and the beam edge, the Easy Roller allows for less wear on the fabric, while maintaining cover performance.





Aluminum Lid

Our standard lid for both Universal track and Underside™ track systems offers an economical way to conceal and protect the mechanism (*not intended to be walked on*).



Flush-mount Lid

Our flush-mount lid is a walk-on lid that completely covers a recessed pool cover mechanism while remaining even with the surface of the deck.



Flat Bezel™ Lid

Designed for Underside track systems, the flat Bezel lid gives step-on strength with a more streamlined appearance and beveled edges.



Tilted Bezel Lid / Stepped Bezel Lid

The tilted (shown) or stepped Bezel lid for Universal track systems features step-on strength with a narrow tilt or low-profile rise to accommodate the track. It also has beveled edges.

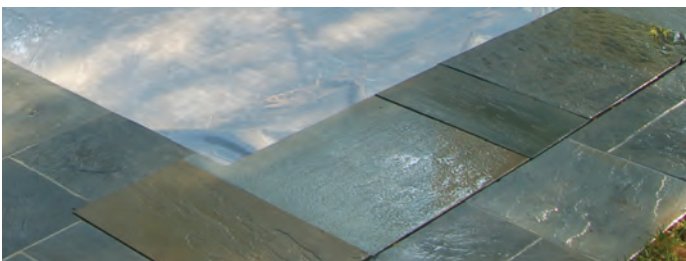

Vanishing Lid™

The Vanishing Lid provides the most integrated look for concealing the mechanism. Your coordinating deck material hides the mechanism housing and blends into the rest of the deck.



Extended Vanishing Lid

The extended Vanishing Lid system is designed to allow the cover to retract completely under the lid. This requires the lid system to be 18" to 24" wide.

All aluminum lids can be powder coated to coordinate with your deck. Choose from a selection of standard colors or special-order colors. Please see Powder-Coated Extrusion samples when making color choice. Colors may vary.

Sky White

Autumn White

Almond

Coffee Tan

Camel

Gray 240

ASA-61 P Gray

Statuary Bronze

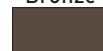
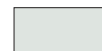
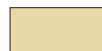
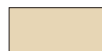
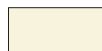

T4 Automatic Pool Cover System



with STAINLESS STEEL CABLE

The T4 is the first and only automatic pool cover system designed for stainless steel cable.

- 1 New Condensed Motor with Potted Capacitor
- 2 Thick Hard-Coated Anodizing on marine-Grade Aluminum Brackets
- 3 Industrial Grade Slip Clutch
- 4 Adjustable Reel Diameter
- 5 Auto-Tension CorrResist™ Cable Reels with Quick-Cable Attachment
- 6 Vertical Pulleys (poolside)
- 7 Reel Brake
- 8 Positive/Sure-Shift Drive
- 9 Drum Brake
- 10 Large 1-1/2" Pulleys
- 11 Quick Install Cradle
- 12 Adjustable CorrResist End Hub

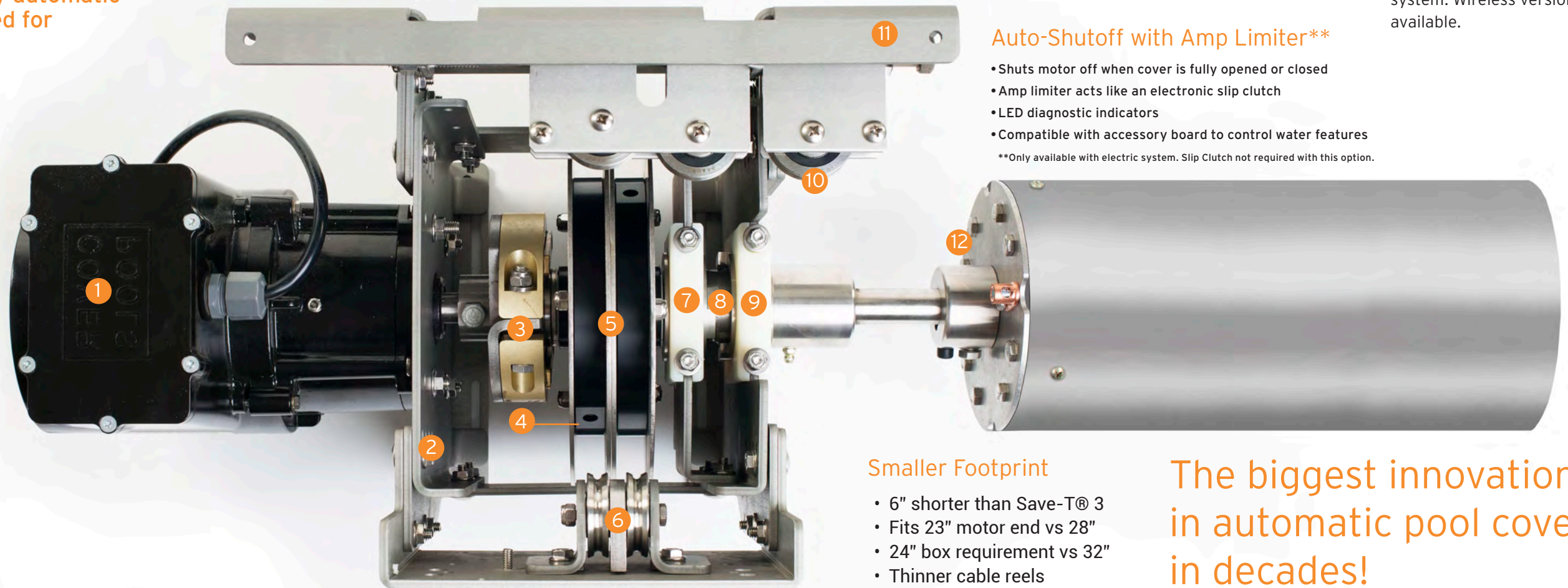

Key or Toggle Switch

Turn the key or toggle the switch to cover or uncover your pool. To maintain a secure system, simply remove the key or lock the toggle switch cover after you've covered the pool.



CoverLink™ Digital Control

The code-accessed digital control system allows you to program up to four codes to create convenient and secure access to the system. Wireless version also available.

Auto-Shutoff with Amp Limiter**

- Shuts motor off when cover is fully opened or closed
 - Amp limiter acts like an electronic slip clutch
 - LED diagnostic indicators
 - Compatible with accessory board to control water features
- **Only available with electric system. Slip Clutch not required with this option.

Smaller Footprint

- 6" shorter than Save-T® 3
- Fits 23" motor end vs 28"
- 24" box requirement vs 32"
- Thinner cable reels
- shifting mechanism uses less space

The biggest innovation in automatic pool covers in decades!



Superior Durability

- Built for aircraft-grade stainless steel cable
- No stretching or shrinking like traditional rope
- No more service calls due to misaligned covers



Easy Installation

- Separate mounting cradle contributes to a quicker installation
- Adjust the leading edge with the turn of a screw while uncovering the pool
- What was once a two-person job is now only a one-person job



Maximum Adjustability

- Auto-Tension torsion springs keep tension on cables ensuring smooth cable pickup
- Reel Diameter Adjustment makes for easy leading edge alignment for a flush cover seal every time



Hydraulic System Option

For special site conditions or for those who prefer hydraulics, the Cover-Pools powerful hydraulic system provides more compact components and increased space efficiency. Its sensitive pressure-release system allows for adjustable power and a built-in automatic shutoff.

STAINLESS STEEL CABLE



Stainless Steel Innovation

At Cover-Pools, we pride ourselves on being the only automatic pool cover manufacturer offering high strength stainless steel cable as an alternative option to traditional rope. Using stainless steel cable means superior durability, less pool cover adjustments and easier fabric replacements. Backed by a seven-year warranty, this steel cable is built to last. That means never fixing misaligned pool cover ropes again. Less adjustments saves you time and money.

- **Superior Durability***

This high-strength stainless steel cable offers superior durability in a pool environment.

- **Minimize Stretching***

Stainless steel cable eliminates stretching associated with the frequent opening and closing of automatic covers.

- **Minimize Adjustments***

By minimizing stretching and shrinkage, stainless steel cables virtually eliminate the need for realignment. No more service calls for rope adjustments.

- **Long Lasting**

The new automatic pool covers with stainless steel cables will keep your pool cover running without the hassle of stretching or shrinking and provide ultimate durability that lasts.

*When installed by a trained Cover-Pools dealer and maintained in accordance with instructions and owner's manual

The Intelligent Pool Cover

With the iAquaLink, pool owners can easily control pool features with a smart phone. When the cover is closed, AquaLink® will deactivate any water features, limit chlorine output, and reduce pump run time saving up to 50% on energy and chemicals.

By including a Cover-Pools Interface Board with their purchase of a Jandy Pro Series AquaLink control system, pool owners gain the following functionality:

- The One Touch™ controller and iAquaLink show whether the pool cover is open, closed, or partially open.
- The salt chlorine production levels automatically adjust when the cover is opened or closed.
- Water features, booster pump cleaners and pool lights will automatically shut off when the cover is closed.
- The filter pump run time will automatically decrease when the cover is closed.

This increased functionality will **automatically**:

- Save energy and operating costs.
- Lengthen the life of the salt cell.
- Avoid over chlorination of the pool.
- Save water, protect the cover, and give pool owners extra peace of mind.

**** The app cannot operate the cover as the control must be mounted in view of the pool.**

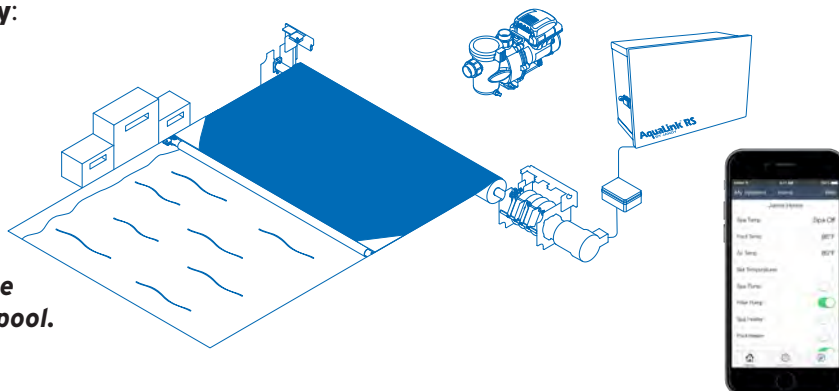

Apple® is not a participant or sponsor of this promotion.

iAquaLink™

Pump Run Time: 10 Hours
Chlorinator: 80%
Spa Overflow: On
Water Features: On
Booster Pump Cleaner: On
Lights: On

Pump Run Time: 5 Hours
Chlorinator: 20%
Spa Overflow: Off
Water Features: Off
Booster Pump Cleaner: Off
Lights: Off

Automation

Operating the automatic cover is as easy as turning a key or pressing a button. For safety, the cover stops as soon as the control is released. Press the button and the cover glides across the pool in under a minute. You can even coordinate water features, lights and other accessories to work with your automatic system.

Auto-Shutoff Control with Optional Accessory Board

The auto-shutoff control stops the cover automatically when it is fully opened or closed. The accessory board controls operation of water features, fiber optics, alarms, etc., in conjunction with opening and closing the cover.

Automatic Water Pump

Cover-Pools systems use an automatic pump (as required by ASTM safety standards) to conveniently remove standing water that may accumulate on top of the cover as a result of rain, sprinklers or cleaning. The pump automatically turns itself on when water is present and shuts off once the water has been removed.

DESIGNED TO PERFORM IN ALL POOLS – SALT WATER POOLS INCLUDED

CorrResist™

Cover-Pools recognizes that a swimming pool environment can often be harsh on a pool's components. Chlorine and other chemical usage, and more recently the popularity of salt water pools have combined to challenge manufacturers to re-engineer their products. Accordingly, Cover-Pools introduced its CorrResist line of products. We anodize our roller drum. We provide hybrid end hubs and rope reels which use both stainless steel and polymers to reduce corrosion. This level of protection is accomplished without any of the problems associated with introducing zinc anodes into the pool.

Mechanism Brackets

- All stainless-steel drive components
- Marine-grade anodized aluminum components

CorrResist End Hub

- End hub with stainless-steel and durable polymer parts prevent corrosion
- High-density polymer tube mounts break the corrosive path between dissimilar metals

Marine-Grade Anodized Aluminum Tube

- Anodized tube creates an armored shield against corrosion
- **Coated tube end upgrade** - additional polyurethane coating that encases the tube ends with a protective shield

Cable Reel System

- Noryl® copolymer center hub isolates and breaks the corrosive path
- High-grade stainless-steel rope reel plates resist corrosive conditions

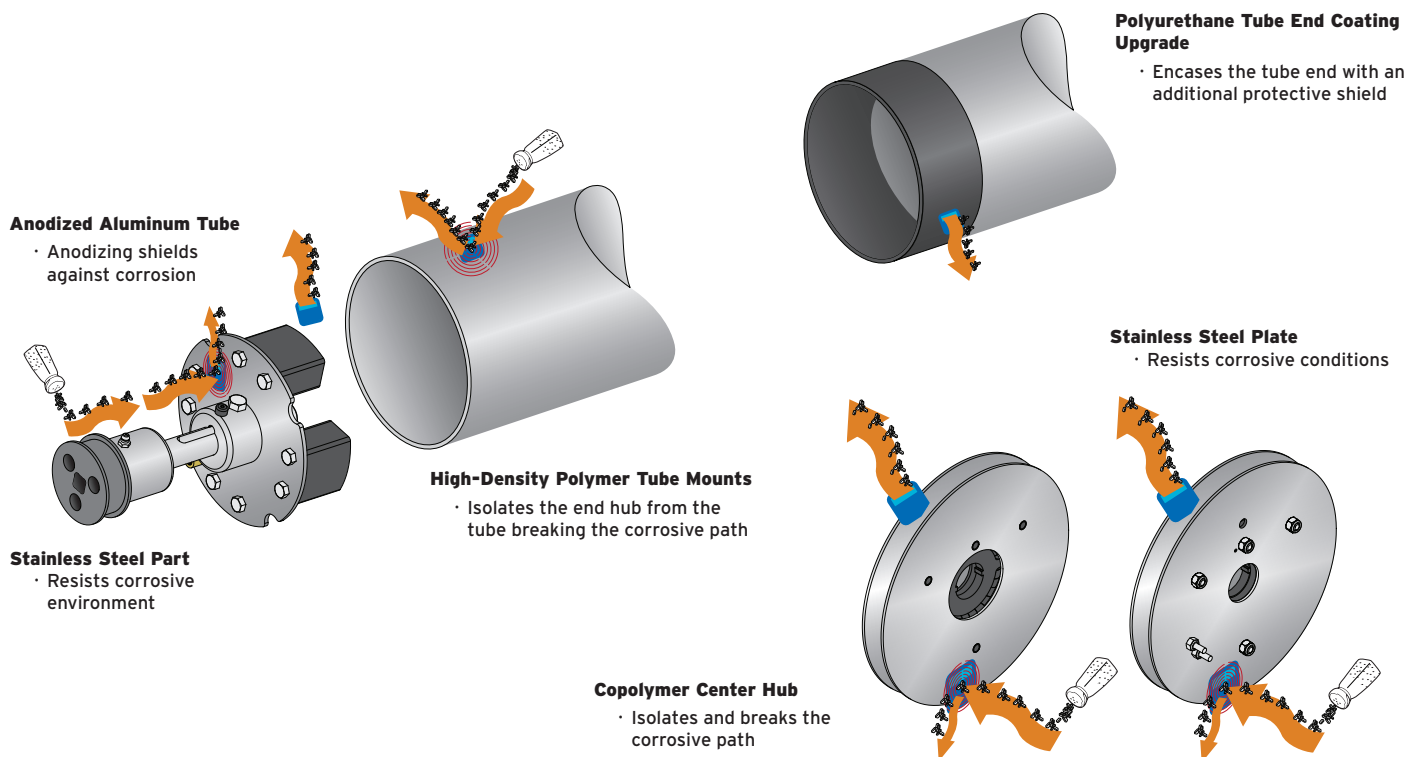



**THE ONLY STANDARD
WARRANTY COVERING
SALT WATER POOLS**

WARRANTIES

We have over 55 years of experience to support our warranties. You can stand on our reputation.

- Lifetime warranty—slip clutch, mechanism
- 7 year warranty—fabric*, lid assembly, tracks, leading edge, and roller tube
- 3 year warranty—motor, electrical, components, and cover pump



*7 year fabric warranty as follows: First 2 years is full warranty and 3-7 years are prorated

6 REASONS WHY WE ARE THE WORLD'S FINEST POOL COVER COMPANY

1 The most experienced automatic pool cover company in the world

When our founder, Joe Lamb, invented and patented the automatic pool cover, he also launched a new industry. Since 1962, Cover-Pools has created over 125,000 safer pools around the world.



2 The most options for customization

Every pool is special. That's why we make your cover system to your custom specifications. Cover-Pools offers a wealth of options to blend your cover system into your outdoor living area. This means that you choose the right combination of safety, convenience, value, and beauty.

3 The most experienced and extensive network of dealers

With knowledgeable dealers in 50 states and over 50 countries, Cover-Pools covers the world. Cover-Pools holds annual APSP-accredited seminars for intensive dealer training and also provides in-field dealer support.



4 The most time-proven warranties in the industry

At Cover-Pools, we believe that the best warranties are backed by the most reliable companies. We have over 55 years of experience to support our warranties. You can stand on our reputation.



5 The most responsive customer-service team in the industry

Our customers constantly tell us that it's the people of Cover-Pools that make their experience so wonderful. When you call Cover-Pools, you reach a live person to provide you with knowledgeable solutions. Every employee at Cover-Pools contributes to customer service—from the production staff to the president, you know you're in capable hands.



6 The most innovative engineering team

To our design team, it's the little things that make Cover-Pools systems so reliable. Always on the leading edge of innovation, our engineers use the latest technology to ensure you receive The World's Finest Pool Cover.



All illustrations and specifications contained in this brochure are based on the latest product information available at the time of printing. Cover-Pools reserves the right to make changes at any time without notice, in colors, materials, equipment, specifications, and models.

Cover-Pools systems and parts are available through independent dealers/distributors worldwide. No dealer/distributor is an employee, agent, or representative of Cover-Pools Incorporated.

Cover-Pools®, Save-T® and Step-Saver® are registered trademarks and Autosave™, Bezel™ lid, big RED™, Corr-Resist™, CoverLink™, Easy Roller™, Everlast™ bench, PowerWheel™, Quad-Core™ Fabric, QuickAttach™, Slim™ Track, SnapTop™ Track, Thermal-Cover™, Ultimate™, Underside™ Track, Vanishing Lid™, V-Pak™ are trademarks of Cover-Pools Incorporated.

For additional information, call **1-800-447-2838** or visit our photo gallery and website at www.coverpools.com

